



238 Pillow Street
Butler, PA 16001
724-283-4681
724-283-5939 (fax)
www.bwieagle.com

PRODUCT INFORMATION BULLETIN

OVERSPEED MONITOR Fail Safe Overspeed Switch MODEL 22-4100-122-NF

DESCRIPTION

The EAGLE OVERSPEED MONITOR is a highly accurate, fail-safe overspeed detector specifically designed to monitor the speed of conveyors and other rotating apparatus. Incorporating advanced electronic technology and innovative circuitry design, the EAGLE OVERSPEED MONITOR sets the standard for dependable, trouble-free performance.

INSTALLATION

DISCONNECT AC power before proceeding with installation.

1. Mount the socket in the existing control panel or suitable protective enclosure.
2. Install EAGLE PROX SENSOR at drum or drum shaft. See sensor installation section.
3. Make the following connections on the socket:

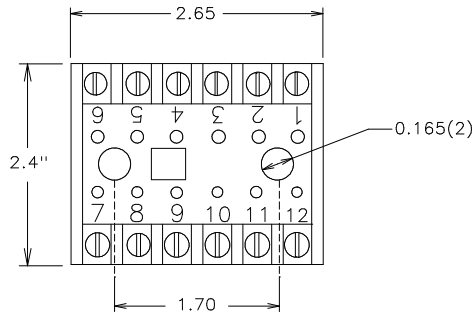

TERMINAL	CONNECTION
1	Sensor Input - Common (-)
2	Sensor Input - Positive (+)
3 - 4	Reset Input - N/C Contacts from PLC or Momentary Switch
5 - 6	120 VAC Input
*7	Relay - N/C (1)
*8	Relay - Common
*9	Relay - N/O (1)
*10	Relay - N/C (2)
*11	Relay - Common (2)
*12	Relay - N/O (2)

* Note - When AC power is applied to the unit, the relay will energize. If an overspeed condition is detected, the relay will de-energize. To reset the unit after an overspeed condition, the normally closed contacts on terminals 3 & 4 must be opened and then re-closed. This clears the overspeed condition and re-energizes the relay.



CONTROLS AND INDICATORS

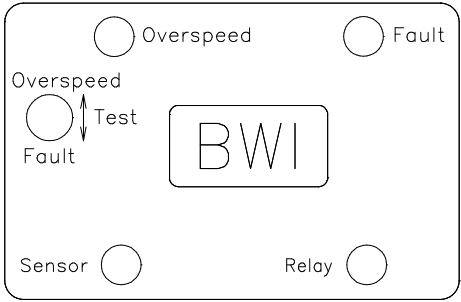

OVERSPEED LED - When illuminated, indicates that an overspeed condition was detected by the unit. This is a latching LED that will automatically reset when the Reset input signal has been activated.

FAULT LED - Not used on this model

SENSOR LED - Pulses at the rate of speed being received by the sensor.

RELAY LED - Illuminated under normal running conditions. LED will go out and relay contacts will open when an overspeed condition is detected.

TEST SWITCH - An integral 2 position switch for testing the control unit. In the "up" (overspeed) position the sensor input signal is internally increased to the preset RPM Trip Point. This provides a "true" simulation of overspeed to ensure the control unit will respond to an actual overspeed condition without the operator having to re-calibrate the unit. The "down" (fault) position is not used on this model.

OVERSPEED MONITOR

Fail Safe Overspeed Switch

MODEL 22-4100-122-NF

DIMENSIONS

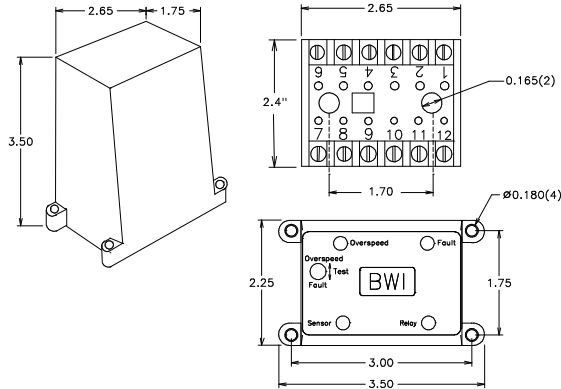

Allow for 5.25" total height with module in socket

SPECIFICATIONS

AC Input	120 VAC 8 W
Fuse Protected	1 amp
Overspeed Trip Point	122 RPM
RPM Accuracy	+/- 0.4%
Repeatability	+/- 0.1%
Relay Contacts	DPDT 5 amp @ 120 VAC
Enclosure	ABS Plastic

REPLACEMENT AND OPTIONAL PARTS

DESCRIPTION	PART NUMBER
Control Module	22-4102-122-NF
Mounting Socket	22-8003
Threaded PVC Proximity Sensor	10-7139
I.S. Threaded PVC Proximity Sensor	10-7039 - IA444-1
I.S. Zener Barrier	10-7072 - IA446-0

DOCUMENT DATE: 9-Sep-02



238 Pillow Street
Butler, PA 16001
(724) 283-4681
Fax (724) 283-5939
www.bwieagle.com

PROX SENSOR

Inductive Proximity Type

MODELS 10-7135, 10-7139, 10-7140

INSTALLATION

1. Select the roller or shaft to be monitored. If a roller is to be monitored, be sure it is always contacting the belt.
2. Affix a target on the roller or shaft. The target should be a piece of key-stock, 1/4-20 Hex Nut, etc. **NOTE:** The use of a notch or a dent is not an acceptable target for the prox sensor. This sensor must see the presence of a target, not an absence of a target as there would be with a notch or dent.
3. Mount sensor firmly with hose clamps or U-bolts to prevent it from moving or working loose. Tape is **NOT** recommended as a fastener.
4. Before tightening, check that the target passes through the center area of the sensor face. This will produce the greatest sensitivity and sensing distance. With the roller or shaft spinning, move the sensor toward the target. The LED on the sensor should blink in direct proportion to the speed of the shaft or roller. Effective distance between the sensor and target is approximately .1 inch to .5 inch depending on the size of the target.

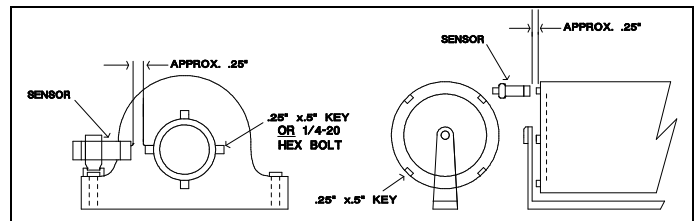

Note: When mounting sensor on small idler rollers (less than 6 inches in diameter), install a maximum of 2 targets

DIMENSIONS

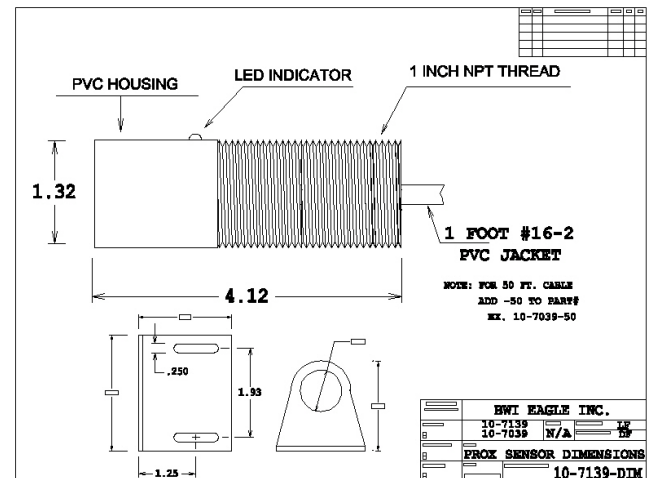

SPECIFICATIONS

Dimensions	4.12 in. x 1.32 in. O.D.
Sensor Type	Inductive Proximity (Metal)
Sensor Power Requirement	Current Limited 12VDC from Control
Unit Sensor Cable	Unshielded Twisted Pair 16/2 **
Distance	SEE NOTE BELOW
Minimum Sensing Speed	Sensor to Control Unit - 2 Miles Less than 1 RPM

**NOTE - Shielded cable is recommended for all above ground applications. The shield of the cable should be attached to earth ground within 2 feet of the sensor head. In severe noise environments, grounding the shield at the control module also, will eliminate any E.M.I. interference.